



ⓘ Discontinued

### Main

Range	TeSys
Product name	TeSys GV7
Device short name	GV7R
Device application	Motor
Poles description	3P
Network type	AC
Utilisation category	AC-3 conforming to IEC 60947-4-1
Network frequency	50/60 Hz conforming to IEC 60947-4-1
Breaking capacity	50 kA Icu at 500 V AC 50/60 Hz conforming to IEC 60947-2 65 kA Icu at 440 V AC 50/60 Hz conforming to IEC 60947-2 100 kA Icu at 220/240 V AC 50/60 Hz conforming to IEC 60947-2 70 kA Icu at 380/415 V AC 50/60 Hz conforming to IEC 60947-2 10 kA Icu at 660/690 V AC 50/60 Hz conforming to IEC 60947-2
[Ics] rated service short-circuit breaking capacity	100 % at 440 V AC 50/60 Hz conforming to IEC 60947-2 100 % at 500 V AC 50/60 Hz conforming to IEC 60947-2 100 % at 220/240 V AC 50/60 Hz conforming to IEC 60947-2 100 % at 380/415 V AC 50/60 Hz conforming to IEC 60947-2 100 % at 660/690 V AC 50/60 Hz conforming to IEC 60947-2
Thermal protection adjustment range	90...150 A
Trip unit technology	Thermal-magnetic

### Complementary

Mounting mode	By clips By screws
Mounting support	Flush Rail Panel mounting Kit for fixing the switchgear
Mounting position	Vertical
Motor power kW	110 kW at 660...690 V AC 50/60 Hz 55 kW at 400...415 V AC 50/60 Hz 75 kW at 400...415 V AC 50/60 Hz 75 kW at 500 V AC 50/60 Hz 90 kW at 500 V AC 50/60 Hz 90 kW at 660...690 V AC 50/60 Hz
Control type	Rocker lever

[Ue] rated operational voltage	690 V AC 50/60 Hz conforming to IEC 60947-2
[Ui] rated insulation voltage	750 V AC 50/60 Hz conforming to IEC 60947-2
[Ith] conventional free air thermal current	150 A conforming to IEC 60947-4-1
[Uimp] rated impulse withstand voltage	IEC 60947-2 8 kV
Power dissipation per pole	8.7 W
Power dissipation per pole	8.7 W
Mechanical durability	40000 cycles
Electrical durability	20000 cycles for AC-3 at 440 V In 40000 cycles for AC-3 at 440 V In/2
Maximum operating rate	25 cyc/h
Rated duty	Continuous conforming to IEC 60947-4-1
Connection pitch	35 mm without spreaders 45 mm with spreaders
Connections - terminals	Bars Cable with lug - external diameter: 10 mm Screw Bare cable connectors 1.5...95 mm <sup>2</sup>
Tightening torque	10 N.m on screw M6 screw type 15 N.m on bare cable connectors for cable 1.5...95 mm <sup>2</sup>
Mechanical robustness	Shocks: 15 Gn for 11 ms conforming to IEC 60068-2-27 Vibrations: 2.5 Gn, 0...25 Hz conforming to IEC 60068-2-6
Suitability for isolation	Yes conforming to IEC 60947-1
Phase failure sensitivity	Yes conforming to IEC 60947-4-1 § 7-2-1-5-2
Height	161 mm
Width	105 mm
Depth	111 mm
Net weight	2.02 kg

## Environment

Standards	NF C 63-650 EN/IEC 60947-2 NF C 63-120 EN/IEC 60947-4-1 VDE 0113 NF C 79-130 VDE 0660 EN/IEC 60947-1
Product certifications	UL DNV
Protective treatment	TC
IP degree of protection	IP405 conforming to IEC 60529 (with terminal shrouds)
Pollution degree	3
Ambient air temperature for operation	-25...70 °C
Ambient air temperature for storage	-55...95 °C
Fire resistance	960 °C conforming to IEC 60695-2-1
Operating altitude	2000 m

## Offer Sustainability

EU RoHS Directive	Not applicable, out of EU RoHS legal scope
Environmental Disclosure	<a href="#">Product Environmental Profile</a>

## Contractual warranty

Warranty	18 months
----------	-----------

## Current Limitation on Short-Circuit (3-Phase 400/415 V)

Dynamic Stress

$I_{\text{peak}} = f(\text{prospective } I_{\text{sc}})$

For GV7RS only

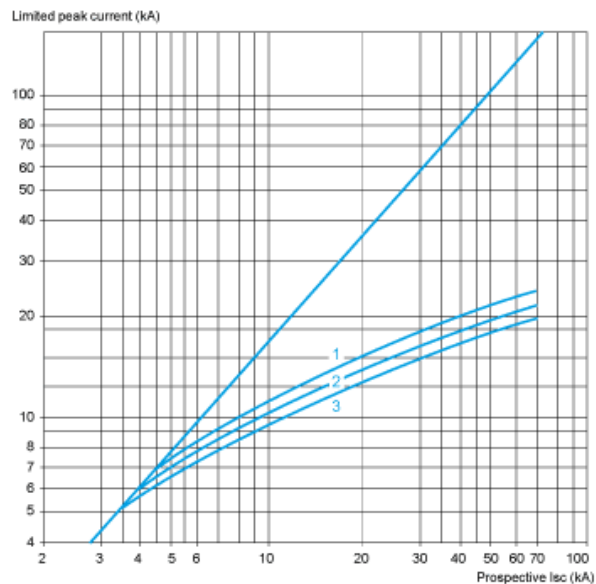

- 1 GV7RS220
- 2 GV7RS150
- 3 GV7RS100

## Thermal Limit (3-Phase 400/415 V)

Thermal Limit

Sum of  $I^2 dt = f(\text{prospective } I_{\text{sc}})$

For GV7RS only

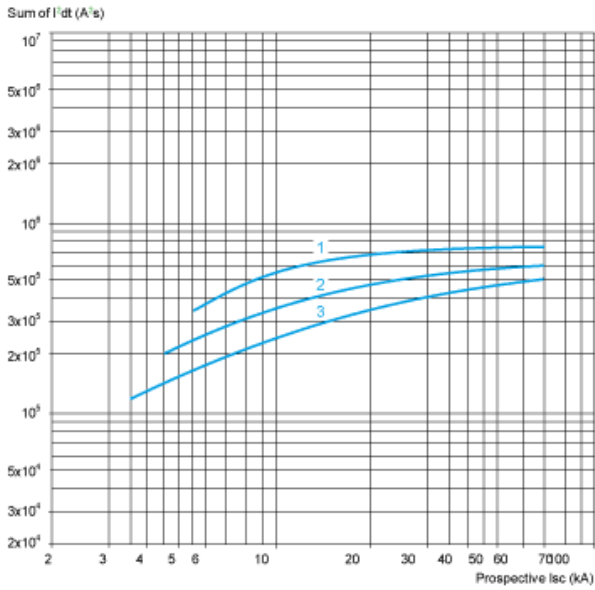

- 1 GV7RS220
- 2 GV7RS150
- 3 GV7RS100

### Current Limitation on Short-Circuit (3-Phase 690 V)

Dynamic Stress

$I_{peak} = f(\text{prospective Isc})$

For GV7RS only

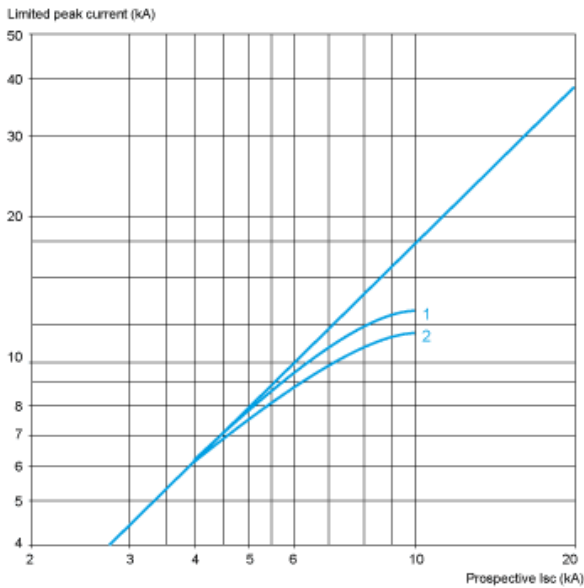

- 1 GV7RS220
- 2 GV7RS150 and GV7RS100

### Thermal Limit on Short-Circuit (3-Phase 690 V)

Thermal Limit

$\text{Sum of } I^2dt = f(\text{prospective Isc})$

For GV7RS only

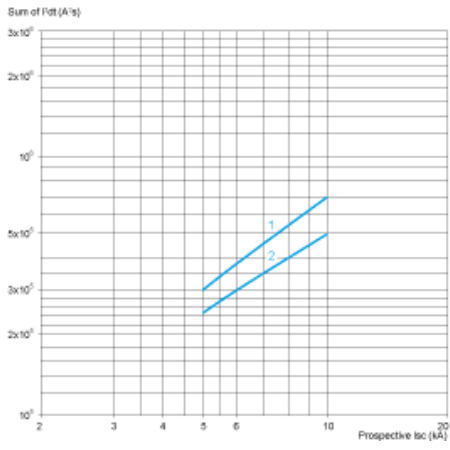

- 1 GV7RS220
- 2 GV7RS150 and GV7RS100

GV7R

Dimensions

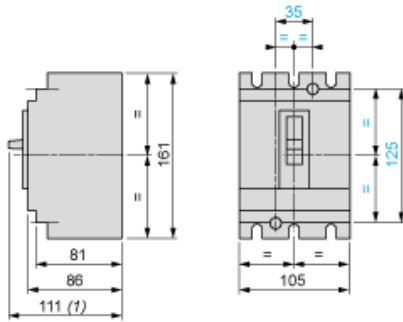

(1) 126 for GV7R.220.

Minimum Electrical Clearance

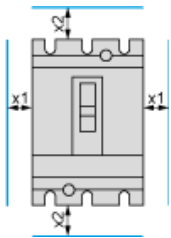

		x1	x2
Painted or insulated metal plate, insulation or insulated bar		0	30
Bare metal plate	$U \leq 440 \text{ V}$	5	35
	$440 \text{ V} < U < 600 \text{ V}$	10	35
	$U \geq 600 \text{ V}$	20	35

GV7R

Panel Mounting

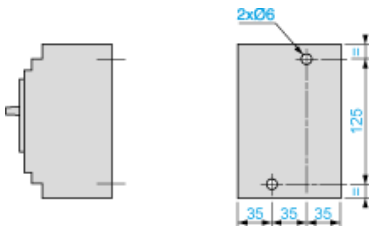

Mounting on 2 Mounting Rails DZ5 MB201

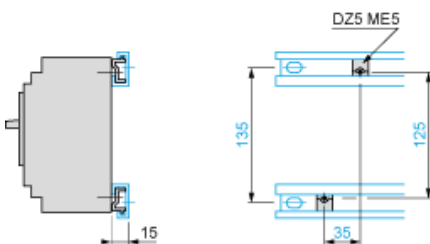

Flush-Mounting

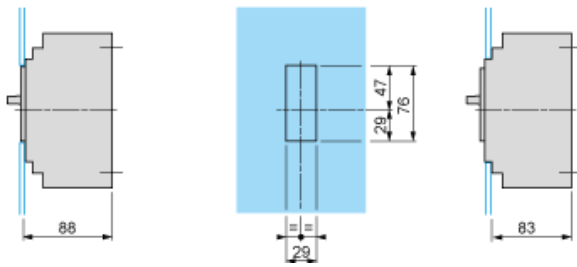

1 circuit breaker GV7R

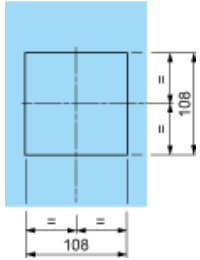

n circuit breakers GV7R side by side

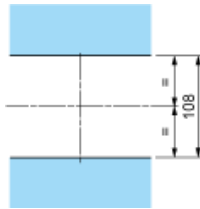

## Connection

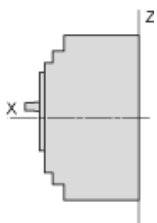

Smooth terminals

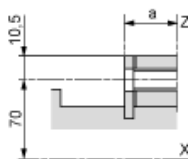

	a
GV7R.40...R.150	19.5
GV7R.220	21.5

Connectors

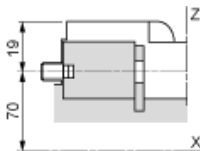

---

---

Motor Circuit Breakers

GV7 R

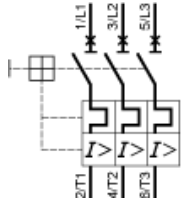

GV7RS150 is replaced by:



**Motor circuit breakers GV5P150H**

Motor circuit breaker, TeSys GV5, 3P, 150A, Icu 70kA, thermal magnetic

Qty 1

Reason for Substitution: End of life | Substitution date: 11 August 2020 | Global group 1

---